



CONNEX ELECTRIC MOTORS

CCITP36-145-002

Premium Efficiency Cast Iron * TEFC * Three Phase Motor

Design B Meets NEMA Premium * IP55 Protection * High Torque * Inverter Duty

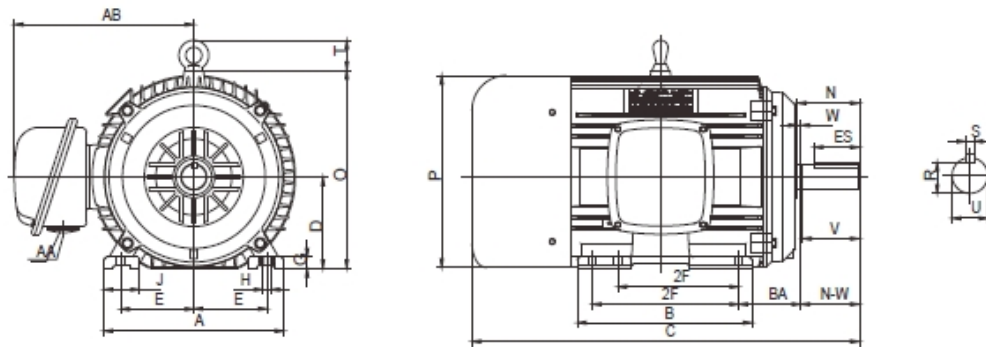

DIMENSIONAL DATA

MOUNTING							CONDUIT BOX		C-FLANGE		
D	E	2F	A	B	BA	H	AB	AA	AJ	AK	N
3.5	2.75	5	7	6	2.25	0.34	7.36	0.75			2.44
MOTOR DIMENSIONS					KEYSEAT				BEARING		
C	O	P	T	N-W	U	R	S	ES	DE	ODE	
15.35	7.52	7.68	1.42	2.25	0.875	0.771	0.188	1.41	6205ZZ	6205ZZ	

PERFORMANCE DATA

50/60 Hz * Class F Insulation * 40°C Ambient * Continuous Duty * 1.15 Service Factor

HP	Frame	Full Load RPM	Efficiency %	Power Factor	Full Load AMPS	Locked Rotor AMPS	VAC	LRT / TN	BRT / TN	APP. WEIGHT
2	145T	3490	85.5	0.85	2.59	25	208-230/460V	170	240	48

CONNEX INDUSTRIAL CORP.

4975 AVALON RIDGE PKWY, SUITE 200, PEACHTREE CORNER, GA 30071

TOLL FREE: 1-877-884-2910 TEL: 770-248-9588 FAX: 770-248-9589

www.connex-electric.com