



CONNEX ELECTRIC MOTORS

CCITP12-256-010

Premium Efficiency Cast Iron * TEFC * Three Phase Motor

Design B Meets NEMA Premium * IP55 Protection * High Torque * Inverter Duty

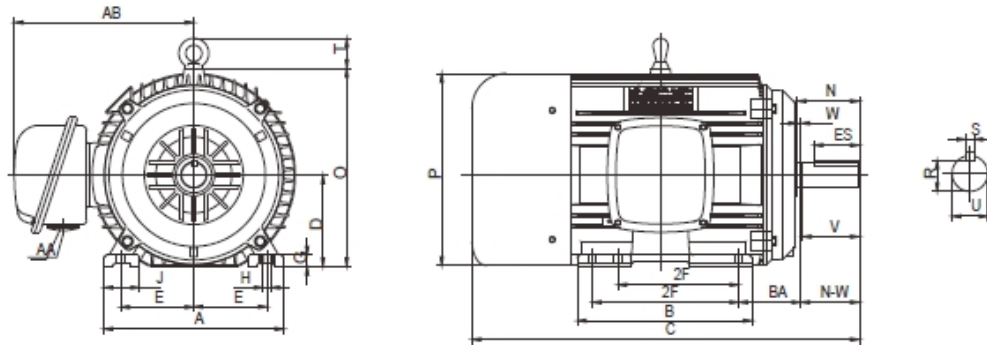

DIMENSIONAL DATA

MOUNTING							CONDUIT BOX		C-FLANGE		
D	E	2F	A	B	BA	H	AB	AA	AJ	AK	N
6.25	5	10	12.3	12	4.25	0.53	12.26	1.25			4.4
MOTOR DIMENSIONS					KEYSEAT				BEARING		
C	O	P	T	N-W	U	R	S	ES	DE	ODE	
27	13.8	13.98	2.05	4.0	1.625	1.416	0.375	2.91	6309C3	6308C3	

PERFORMANCE DATA

50/60 Hz * Class F Insulation * 40°C Ambient * Continuous Duty * 1.15 Service Factor

HP	Frame	Full Load RPM	Efficiency %	Power Factor	Full Load AMPS	Locked Rotor AMPS	VAC	LRT / TN	BRT / TN	APP. WEIGHT
10	256T	1180	91	0.75	13.8	81	208-230/460V	150	200	310

CONNEX INDUSTRIAL CORP.

4975 AVALON RIDGE PKWY, SUITE 200, PEACHTREE CORNER, GA 30071

TOLL FREE: 1-877-884-2910 TEL: 770-248-9588 FAX: 770-248-9589

www.connex-electric.com