



CONNEX ELECTRIC MOTORS

CCITP36-215-010

Premium Efficiency Cast Iron * TEFC * Three Phase Motor

Design B Meets NEMA Premium * IP55 Protection * High Torque * Inverter Duty

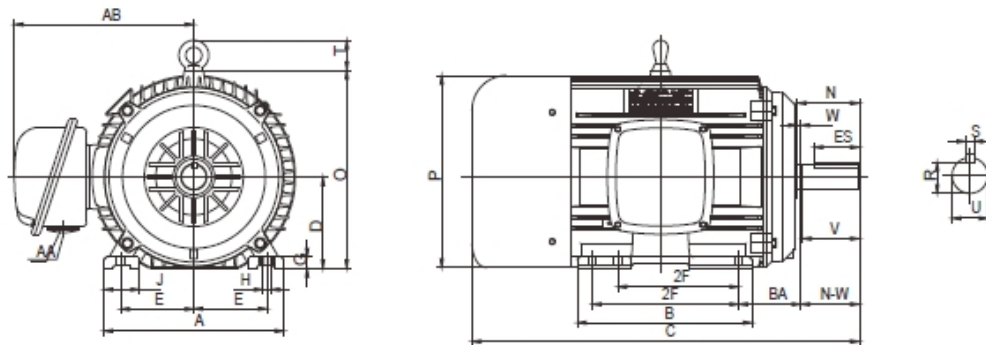

DIMENSIONAL DATA

MOUNTING							CONDUIT BOX		C-FLANGE		
D	E	2F	A	B	BA	H	AB	AA	AJ	AK	N
5.25	4.25	7	10.5	9.4	3.5	0.41	9.65	1			3.65
MOTOR DIMENSIONS					KEYSEAT				BEARING		
C	O	P	T	V	U	R	S	ES	DE	ODE	W
22.25	11.62	11.65	2.05	3.12	1.375	1.201	0.312	2.41	6308ZZ	6306ZZ	173

PERFORMANCE DATA

50/60 Hz * Class F Insulation * 40°C Ambient * Continuous Duty * 1.15 Service Factor

HP	Frame	Full Load RPM	Efficiency %	Power Factor	Full Load AMPS	Locked Rotor AMPS	VAC	LRT / TN	BRT / TN	APP. WEIGHT
10	215T	3500	90.2	0.88	11.9	81	208-230/460V	135	200	3.38

CONNEX INDUSTRIAL CORP.

4975 AVALON RIDGE PKWY, SUITE 200, PEACHTREE CORNER, GA 30071

TOLL FREE: 1-877-884-2910 TEL: 770-248-9588 FAX: 770-248-9589

www.connex-electric.com