



CONNEX ELECTRIC MOTORS

CCITP36-184-005

Premium Efficiency Cast Iron * TEFC * Three Phase Motor

Design B Meets NEMA Premium * IP55 Protection * High Torque * Inverter Duty

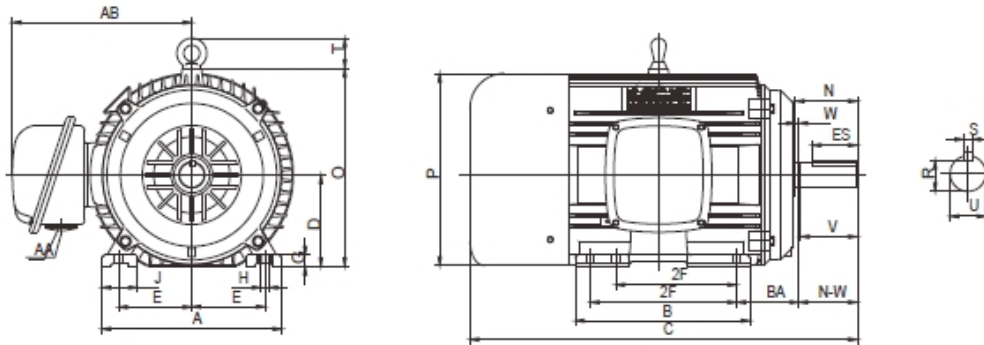

DIMENSIONAL DATA

MOUNTING							CONDUIT BOX		C-FLANGE		
D	E	2F	A	B	BA	H	AB	AA	AJ	AK	N
4.5	3.75	5.5	9	7.3	2.75	0.41	8.66	0.75			2.99
MOTOR DIMENSIONS					KEYSEAT				BEARING		
C	O	P	T	V	U	R	S	ES	DE	ODE	W
17.72	9.83	10.16	1.73	2.5	1.125	0.986	0.25	1.78	6306ZZ	6306ZZ	109

PERFORMANCE DATA

50/60 Hz * Class F Insulation * 40°C Ambient * Continuous Duty * 1.15 Service Factor

HP	Frame	Full Load RPM	Efficiency %	Power Factor	Full Load AMPS	Locked Rotor AMPS	VAC	LRT / TN	BRT / TN	APP. WEIGHT
5	184T	3510	88.5	0.86	6.1	46	208-230/460V	150	215	2.75

CONNEX INDUSTRIAL CORP.

4975 AVALON RIDGE PKWY, SUITE 200, PEACHTREE CORNER, GA 30071

TOLL FREE: 1-877-884-2910 TEL: 770-248-9588 FAX: 770-248-9589

www.connex-electric.com