



CONNEX ELECTRIC MOTORS

CCITP18-447-200

Premium Efficiency Cast Iron * TEFC * Three Phase Motor

Design B Meets NEMA Premium * IP55 Protection * High Torque * Inverter Duty

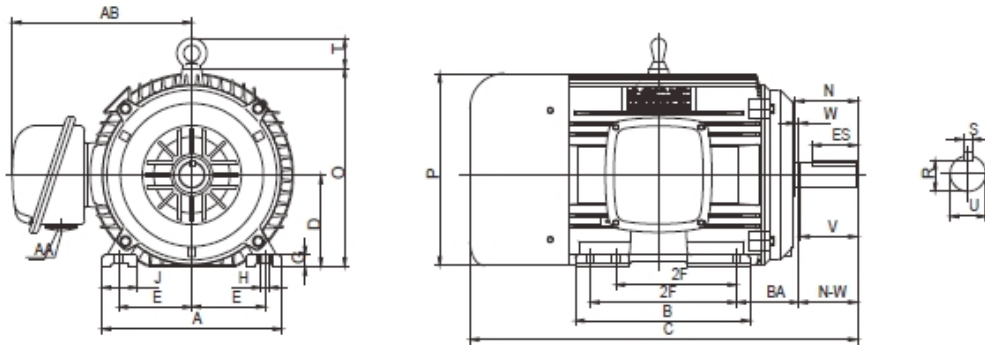

DIMENSIONAL DATA

MOUNTING							CONDUIT BOX		C-FLANGE		
D	E	2F	A	B	BA	H	AB	AA	AJ	AK	N
11	9	20	21.8	28.74	7.5	0.81	20.87	3			8.98
MOTOR DIMENSIONS					KEYSEAT				BEARING		
C	O	P	T	N-W	U	R	S	ES	DE	ODE	
53.55	23.5	23.35	4.1	8.5	3.375	2.88	0.875	6.91	NU319	6314C3	

PERFORMANCE DATA

50/60 Hz * Class F Insulation * 40°C Ambient * Continuous Duty * 1.15 Service Factor

HP	Frame	Full Load RPM	Efficiency %	Power Factor	Full Load AMPS	Locked Rotor AMPS	VAC	LRT / TN	BRT / TN	APP. WEIGHT
200	447T	1780	96.2	0.89	220	1450	208-230/460V	100	200	2195

CONNEX INDUSTRIAL CORP.

4975 AVALON RIDGE PKWY, SUITE 200, PEACHTREE CORNER, GA 30071

TOLL FREE: 1-877-884-2910 TEL: 770-248-9588 FAX: 770-248-9589

www.connex-electric.com